

RF_budget_freq_sweep

Where To Find This Example

AWR Version 14

This example was named in V14, please see [RF_Budget_Frequency_Sweep](#)

AWR Version 13

Select **Help > Open Examples...** from the menus and type either the example name listed above or one of the keywords below.

Or in Version 13 you can open the project directly from this page using this button.

[Open Install Example](#)

Design Notes

RF Budget and Tone Analysis Example

This example makes use of spectrum and RF cascade budget measurements. To only update cascaded measurements click Analyze. To update the spectrum plots as well as cascaded measurements click Run/Stop System Simulators.

Under Options -> Default System Options -> RF Settings you will note that impedance mismatch modeling is enabled. The link must be terminated with a load which is defined by Z parameter of the PORT element or use LOAD element when impedance mismatch modeling is enabled, otherwise the end of the link will be treated as an open circuit. The VSS Modeling Guides provides more information on impedance mismatch modeling in VSS.

Under the Frequency Analysis tab in Default System Options you will see that a frequency range relative to the center frequency of the system has been defined. The RF budget analysis measurements will be performed 0 to 0.2GHz offset from the center frequency in increments of 0.001GHz.

The graph "Cascaded NF over Frequency" shows the cascaded NF at the output of the RF link versus frequency. The NF is calculated within the bandwidth of the last bandpass filter. The frequencies displayed on the x-axis are absolute values as opposed to relative to center frequency. The NF rises outside the bandwidth of the filter. Please read the online VSS Modeling Guide for further information on RF budget measurements as well as noise modeling.

The graph "Cascaded available gain" displays the gain at the center frequency and also at a possible image frequency of 0.7GHz, which is at a 0.2GHz offset from the desired signal of 0.5GHz.

If the bandwidth of the image rejection filter is made narrower or its order is increased, from 4 to 7 for example, the available gain at the image frequency will be reduced and the cascaded NF after the mixer will decrease.

Spectrum plots are shown at several points in the link.

System Diagram - RF System

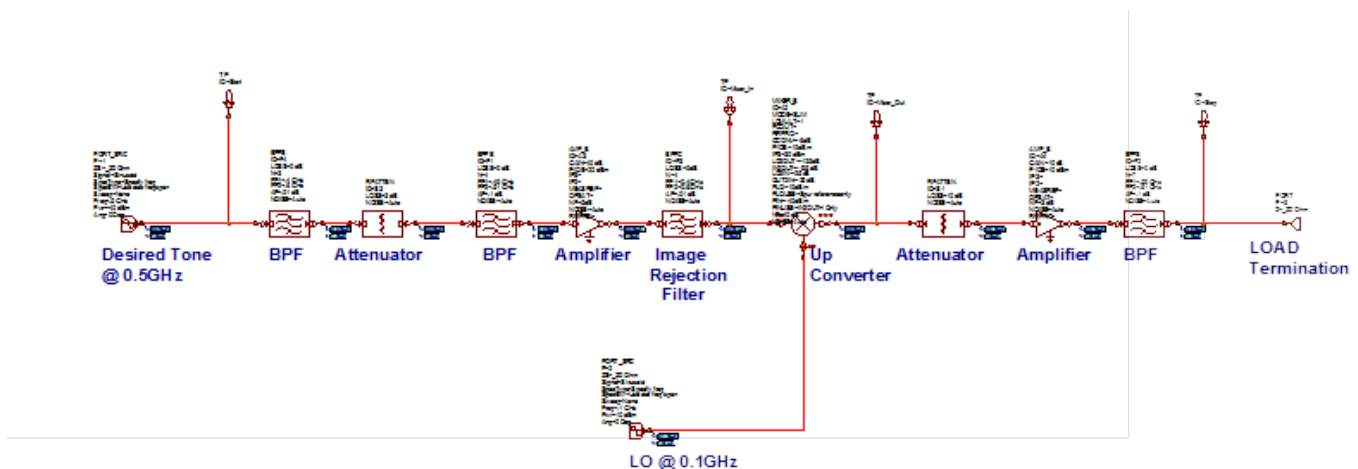

Graph - Cascaded available gain

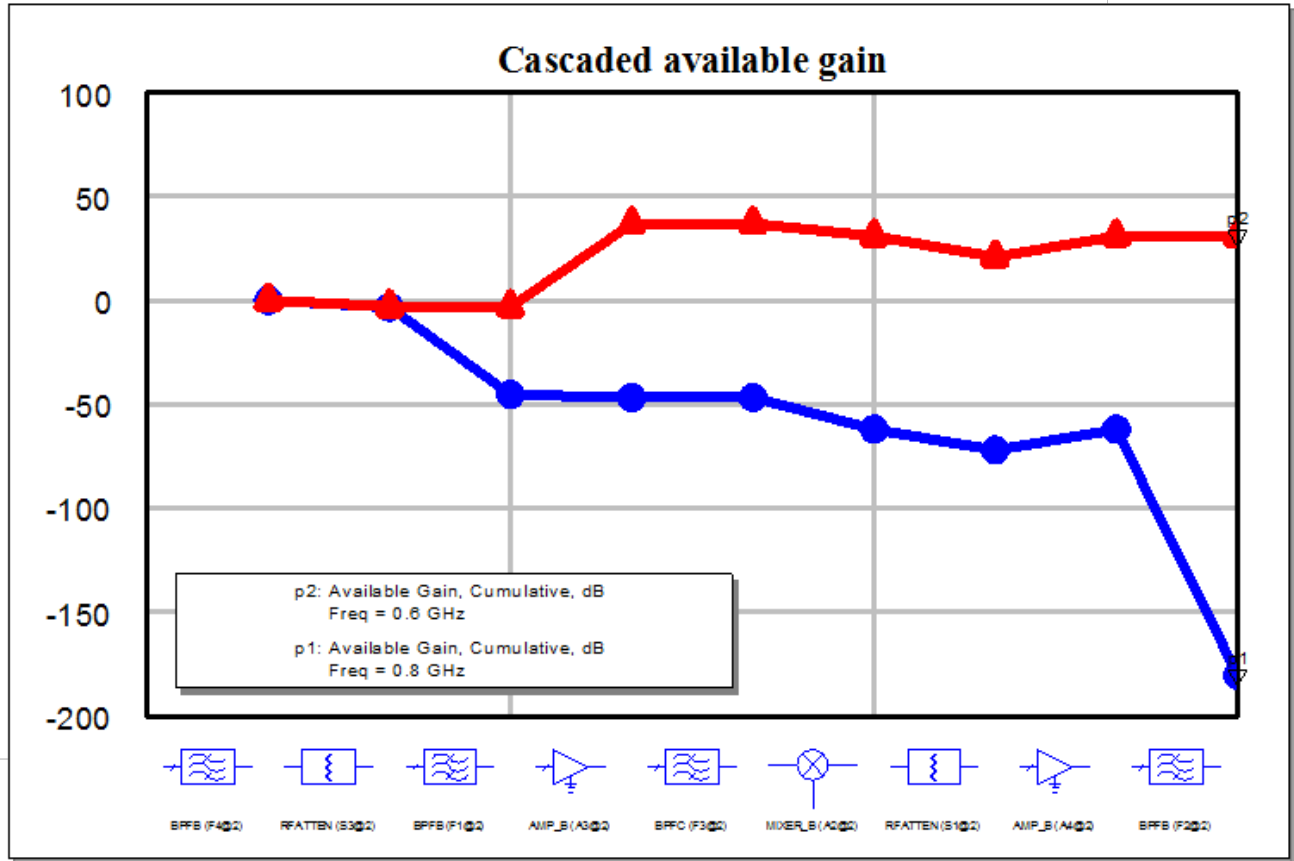

Graph - Spectrum at Mixer output

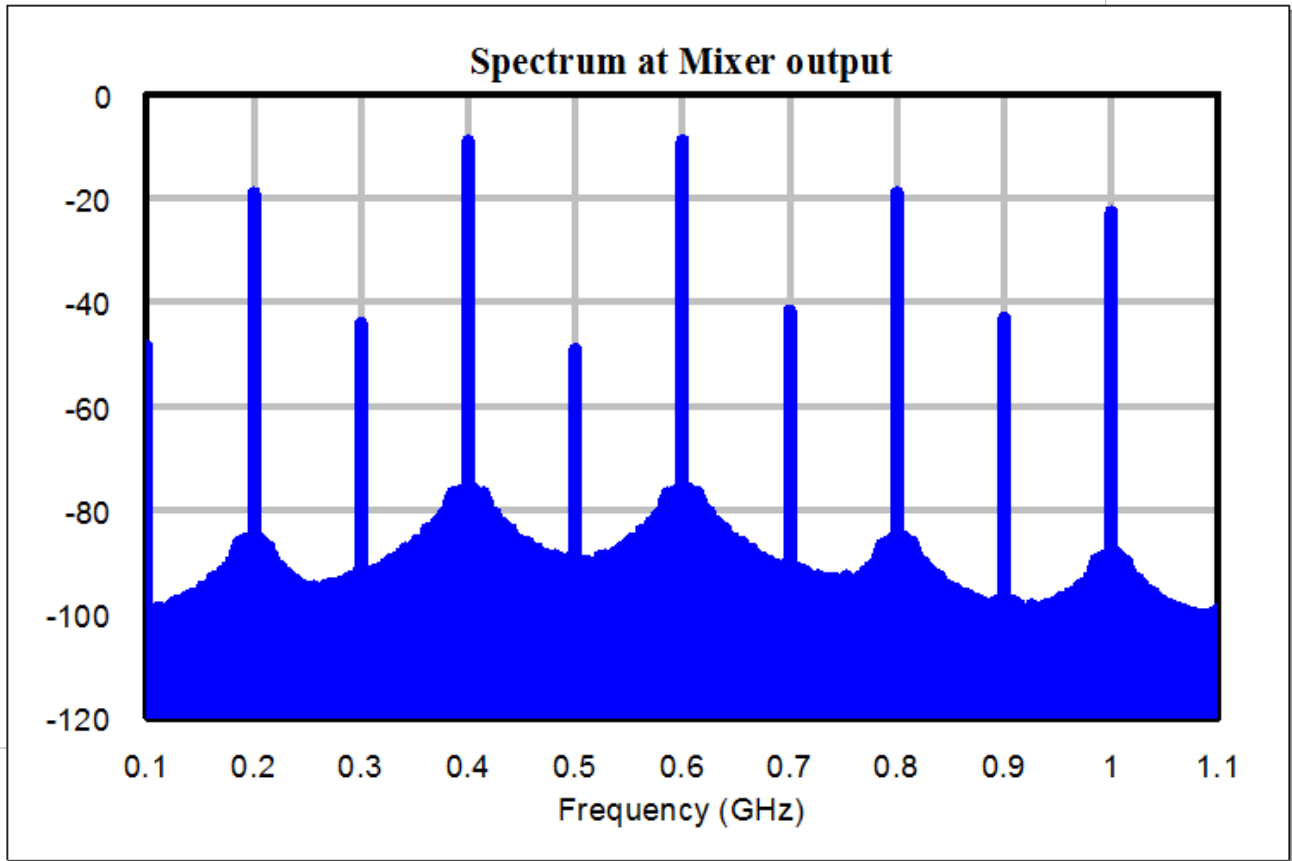

Graph - Spectrum at mixer input

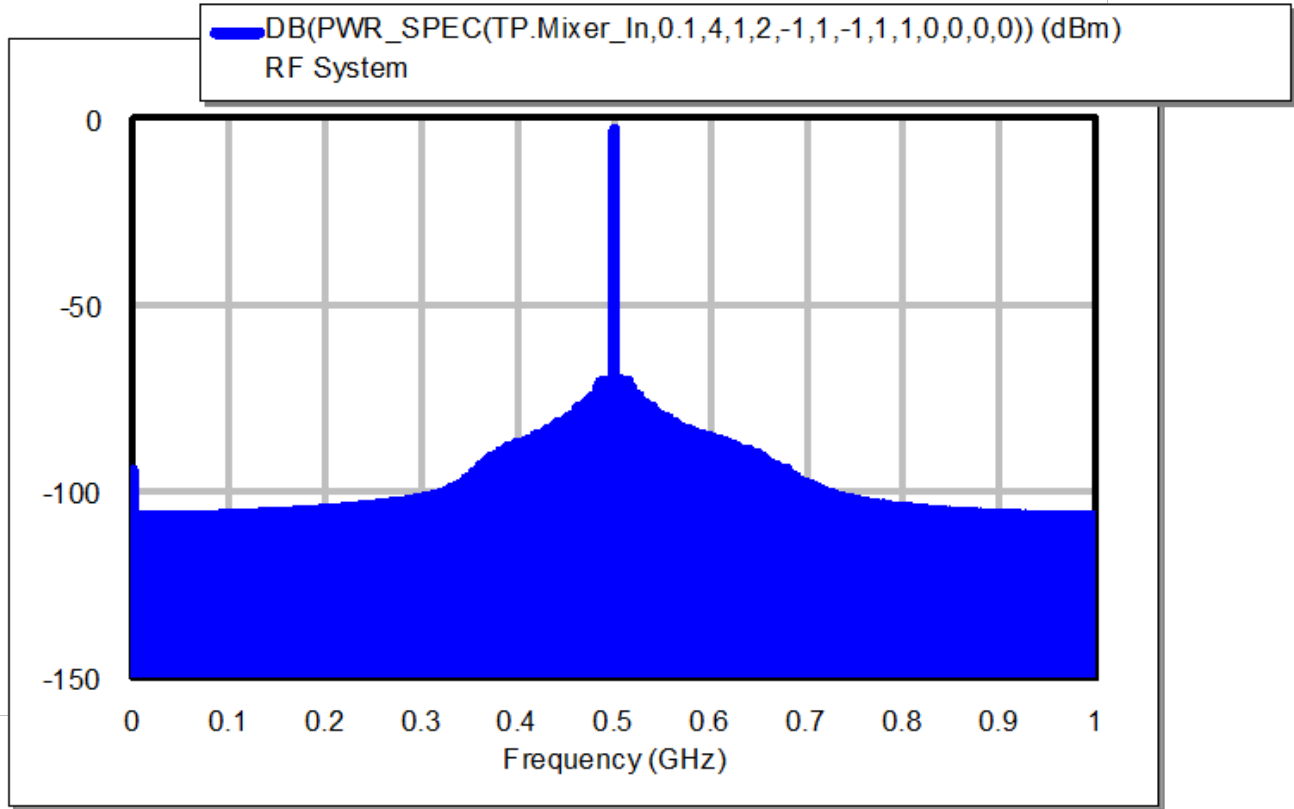

Graph - Spectrum of input

DB(PWR_SPEC(TP.Start,0.1,4,10,2,-1,1,-1,1,1,0,0,0,0)) (dBm)
RF System

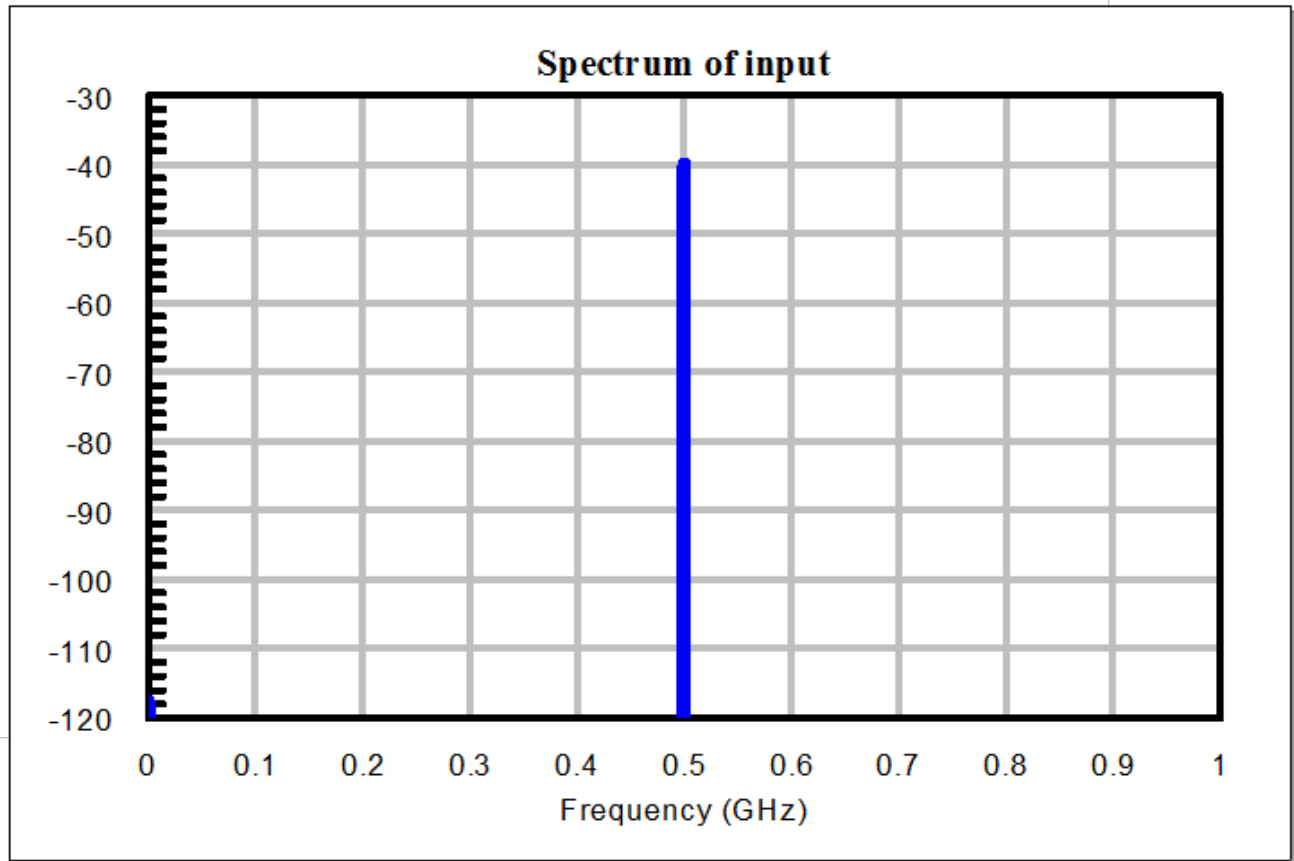

Graph - Spectrum at ouput of RF link

DB(PWR_SPEC(TP.Stop,1,4,1,2,-1,1,-1,1,1,0,0,0,0)) (dBm)
RF System

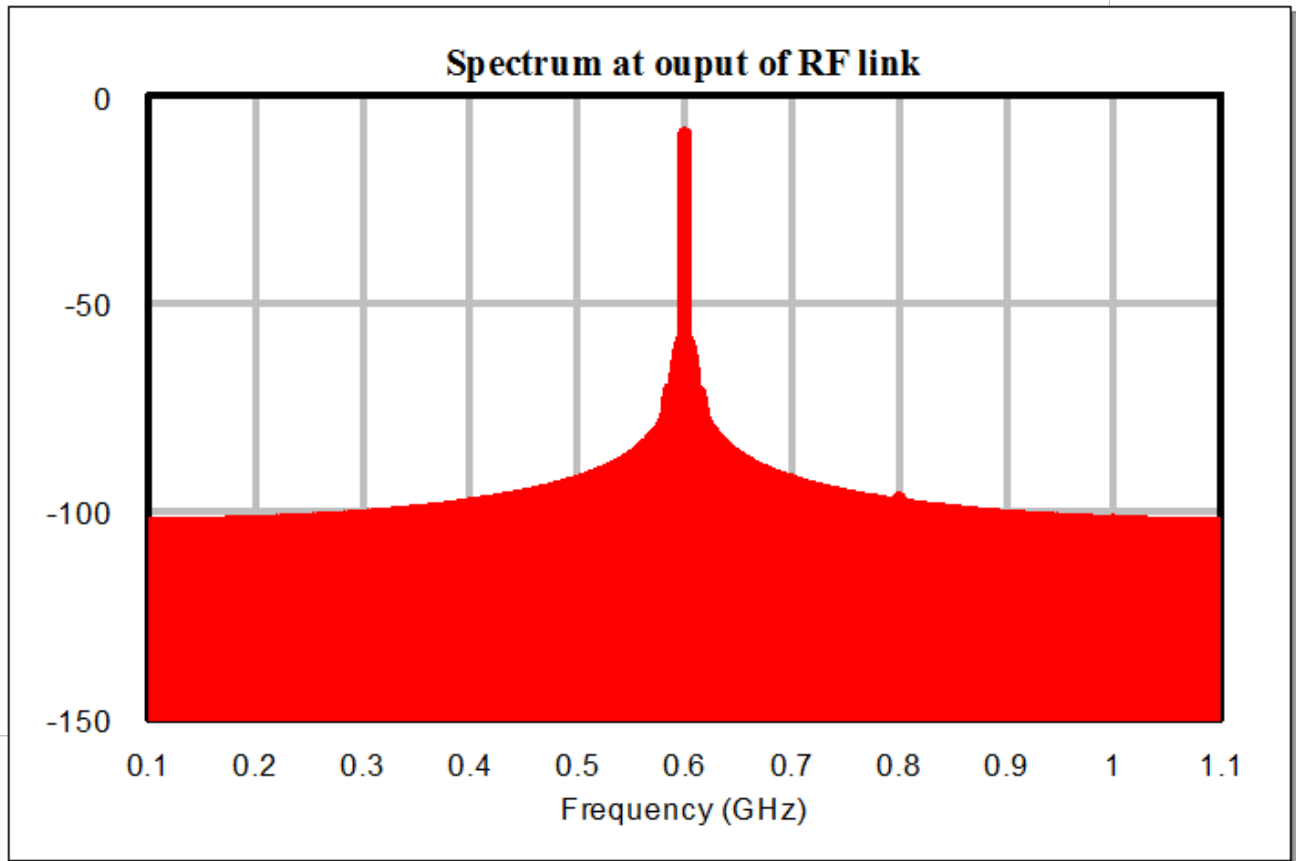

Graph - Cascaded OIP3

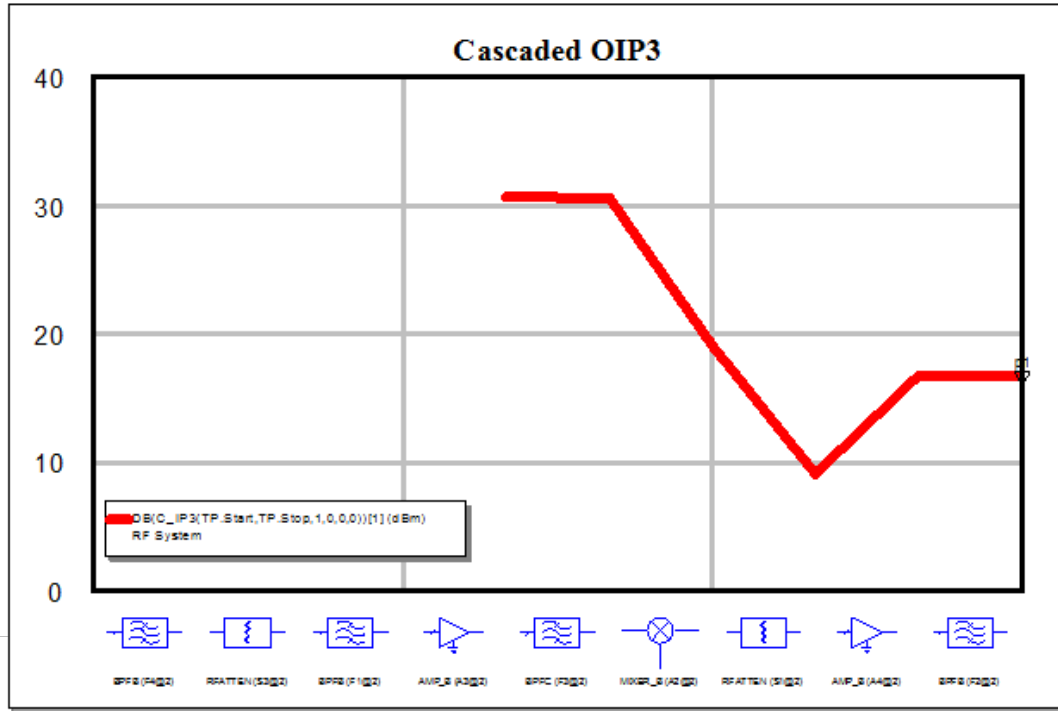

p1: Cascaded OIP3, dBm
Rel. Freq = 0 GHz

Graph - Cascaded NF

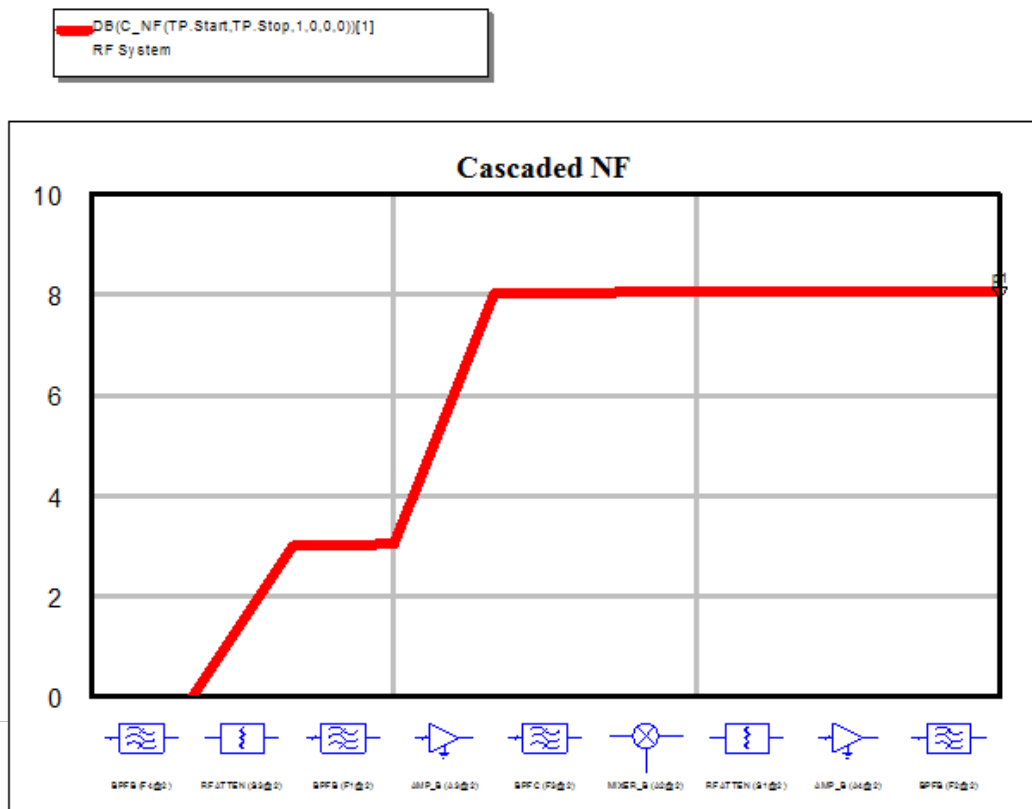

p1: Cascaded Noise Figure, Ideal, Cumulative, dB
Rel. Freq = 0 GHz

Graph - Cascaded NF over Frequency

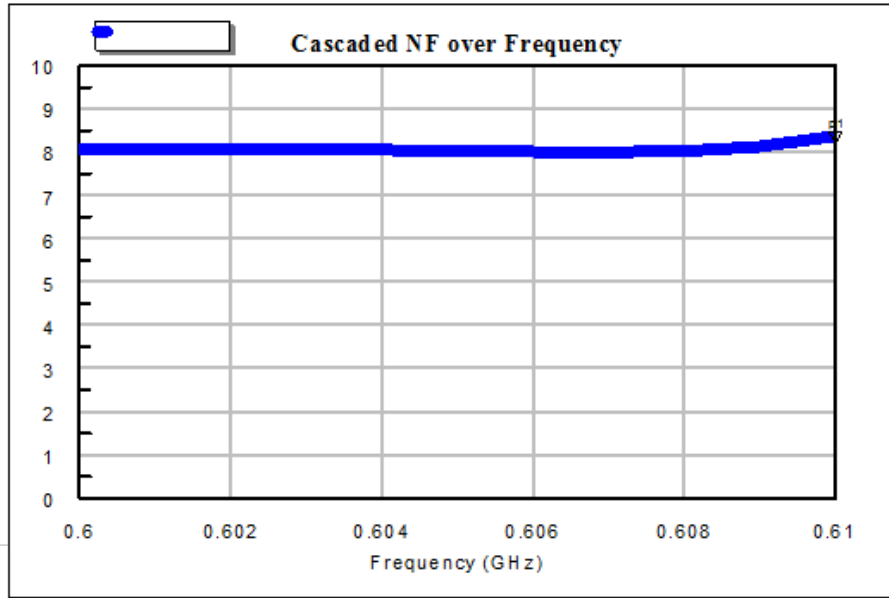

p1: Cascaded Noise Figure, Ideal, Cumulative, dB